

**Handwriting with Handwriting Hank!**

**The Workbook**

**Written and Illustrated by the Lord Jesus Christ**

**Prophet-Pastor Anita Hiltz©2022 All Rights Reserved Worldwide**

I give ALL of the glory to my Father God, the Lord Jesus Christ, and the Holy Spirit for the collection of books which He has written and for the illustrations and lessons He has created - ALL of which would not have been possible without Him. He instructed me to put the copyright in my name and I have obeyed. God's Loving World Ministries™ is a Christian Literacy organization whose mission is to teach remedial reading, writing, math, and English to English as a Second Language Learners FOR FREE.

Psalm 115:1

"<sup>1</sup> Not to us, LORD, not to us  
but to your name be the glory,  
because of your love and faithfulness." (NIV)

In our book called: *Handwriting with Handwriting Hank! Getting Started!* we emphasize the importance of the hand grips and proper paper positions for a Left Handed and Right Handed Person.

A left handed person may begin at the same starting point, to write a letter or number, but reverse the direction. For example: an O may start at the top, but pull to the right instead of the left. Pulled lines are straighter lines, so lines which go straight across like those on the top line of a capital T and the center line on a capital A may be pulled from right to left instead of left to right. If the left handed writer is writing from above where the writing should occur - a line may be pulled from the bottom - up instead of top - down. Although our writing demonstrations show a certain numbered method. We suggest that as long as the writing IS NEAT and MEETS the standard for the formation of the letters, that you allow your lefty to use the method that works for them.

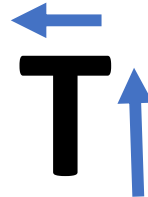
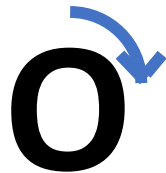

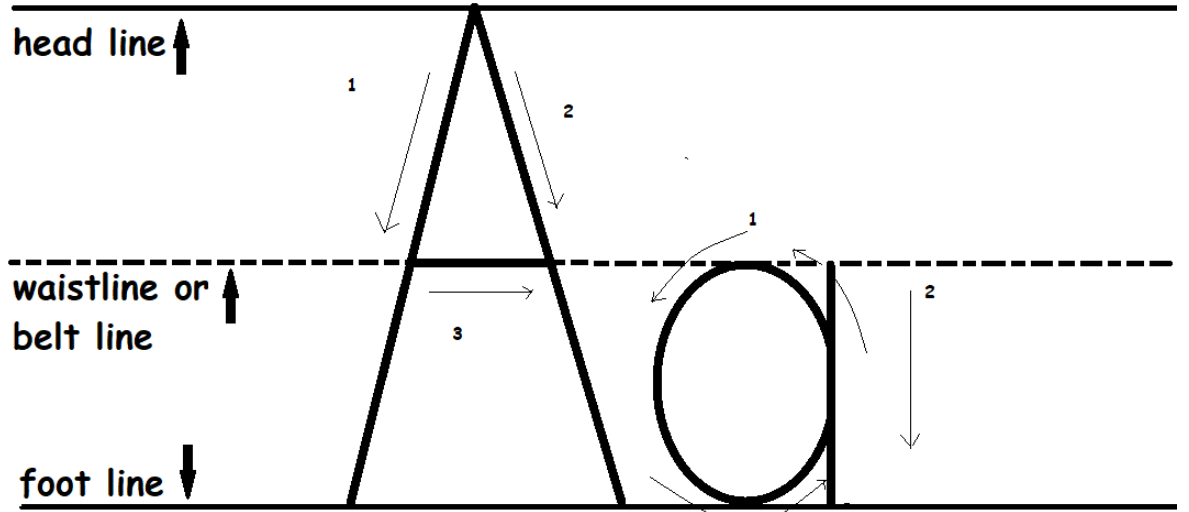
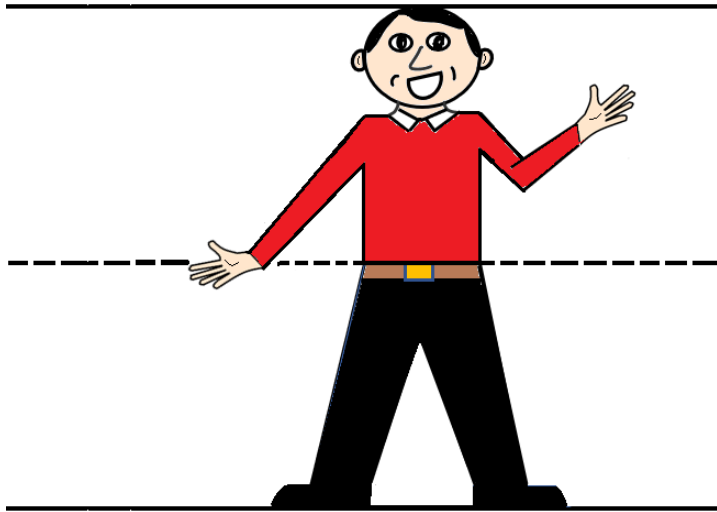

Handwriting practice lines consisting of multiple sets of three horizontal lines: a top solid line, a middle dashed line, and a bottom solid line.

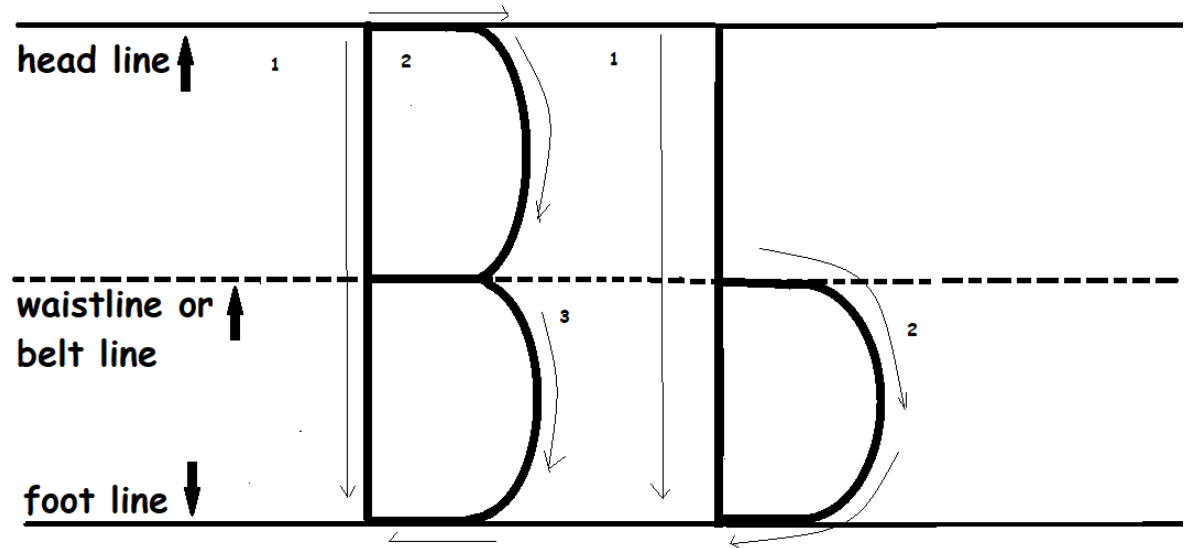
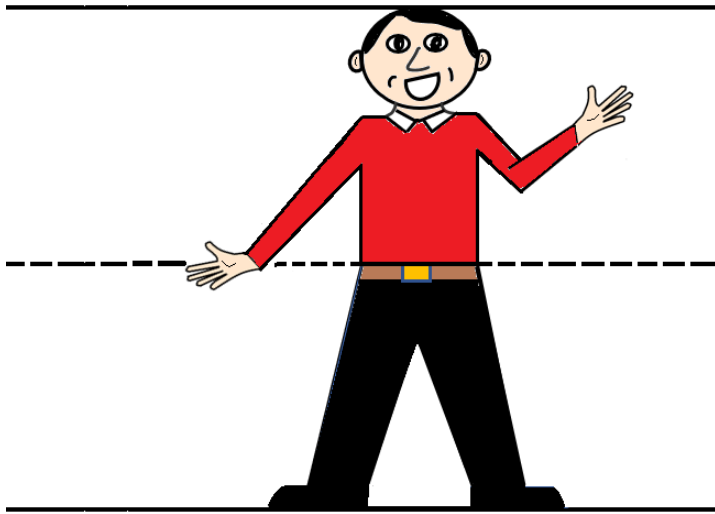

Handwriting practice lines consisting of multiple sets of three horizontal lines (top solid, middle dashed, bottom solid).

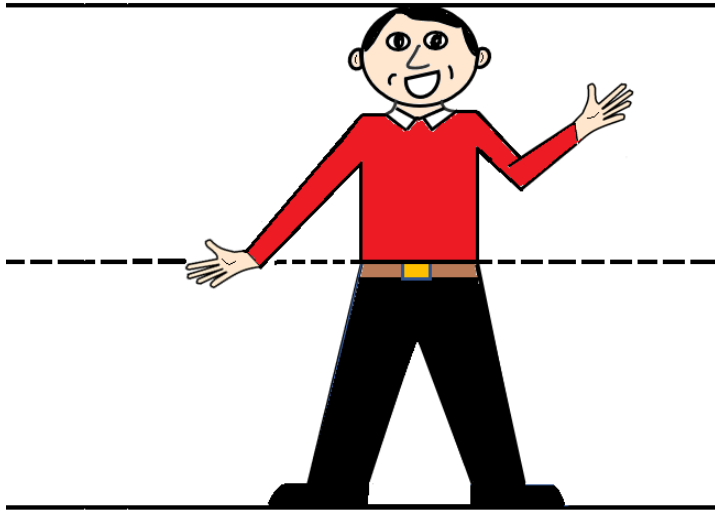

head line ↑

waistline or  
belt line ↑

foot line ↓

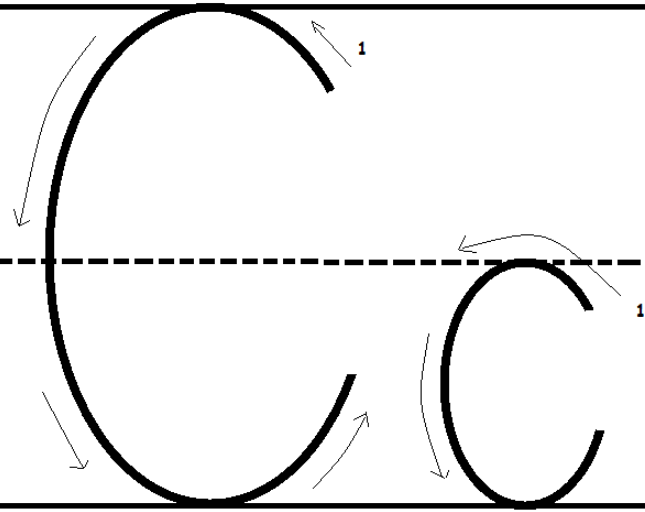

Handwriting practice lines consisting of multiple sets of three horizontal lines (top solid, middle dashed, bottom solid).

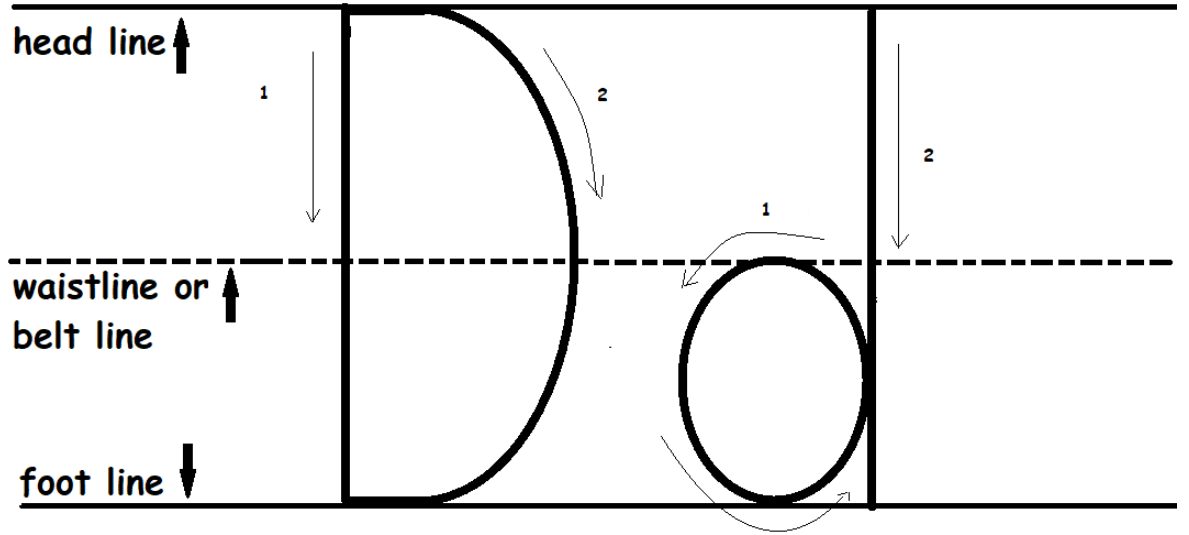
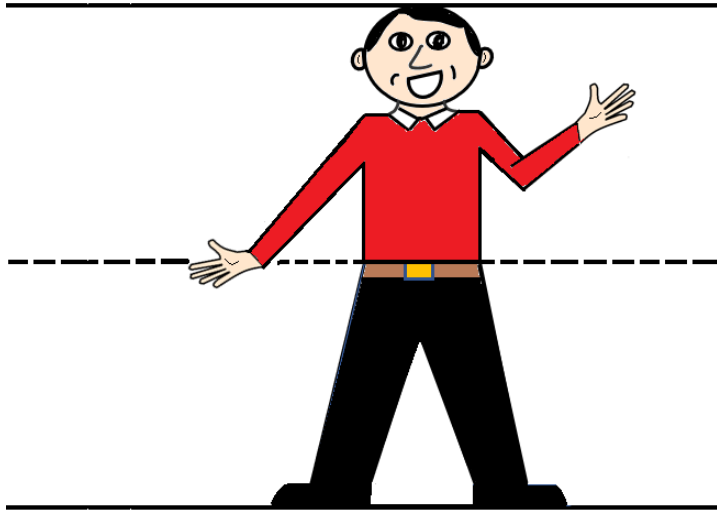

Handwriting practice lines consisting of multiple sets of three horizontal lines: a solid top line, a dashed middle line, and a solid bottom line.

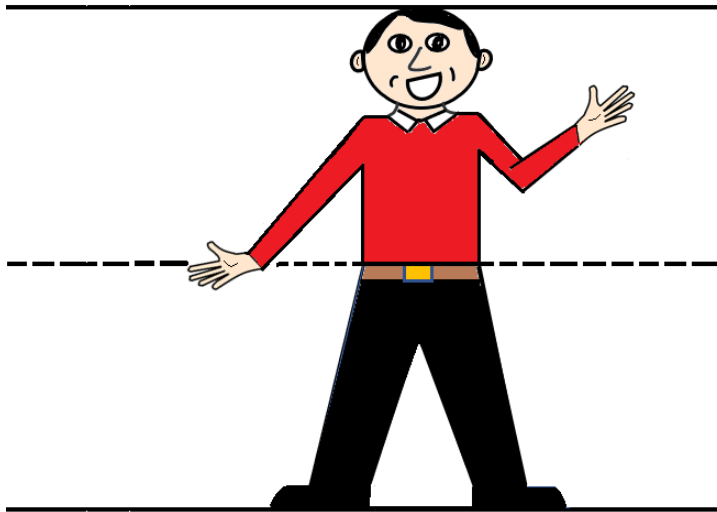

head line ↑

1



waistline or belt line ↑



foot line ↓

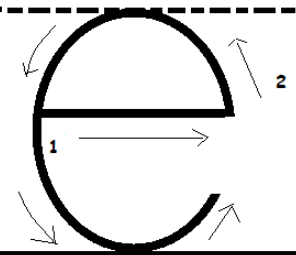
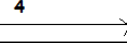

Handwriting practice lines consisting of four sets of three horizontal lines: a solid top line, a dashed middle line, and a solid bottom line.



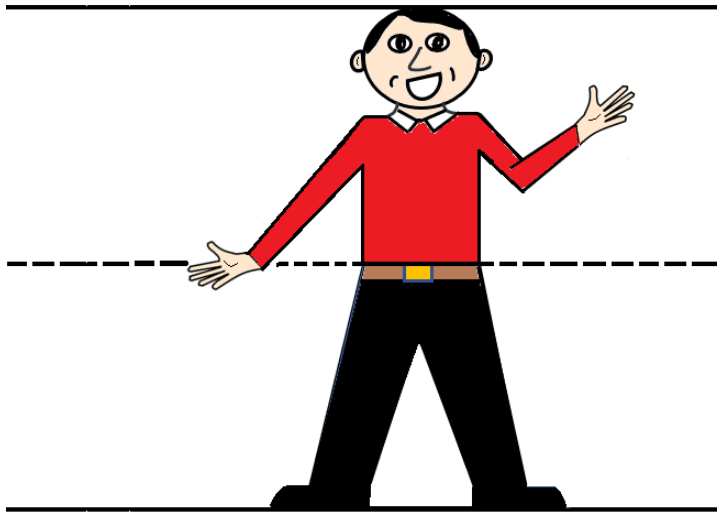

head line ↑

1

waistline or  
belt line ↑

foot line ↓

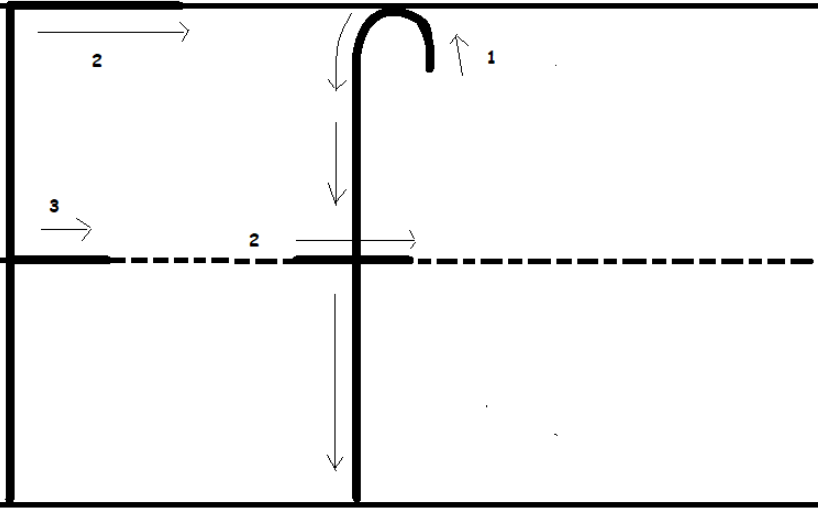

Handwriting practice lines consisting of multiple sets of three horizontal lines: a solid top line, a dashed middle line, and a solid bottom line.

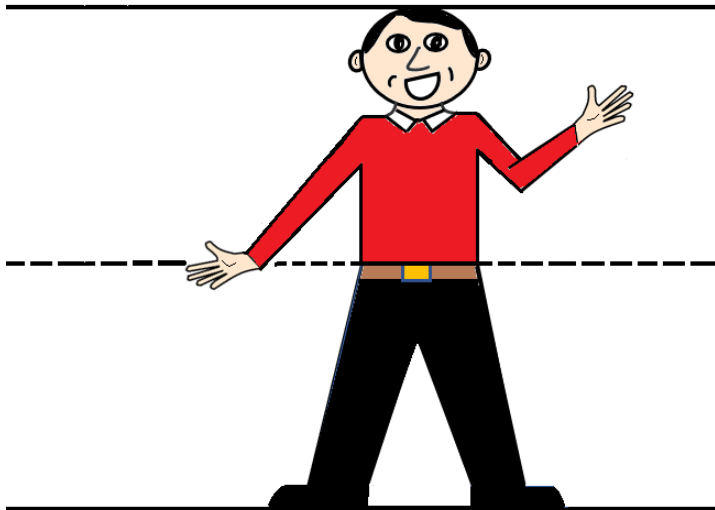

head line ↑

waistline or  
belt line ↑

foot line ↓

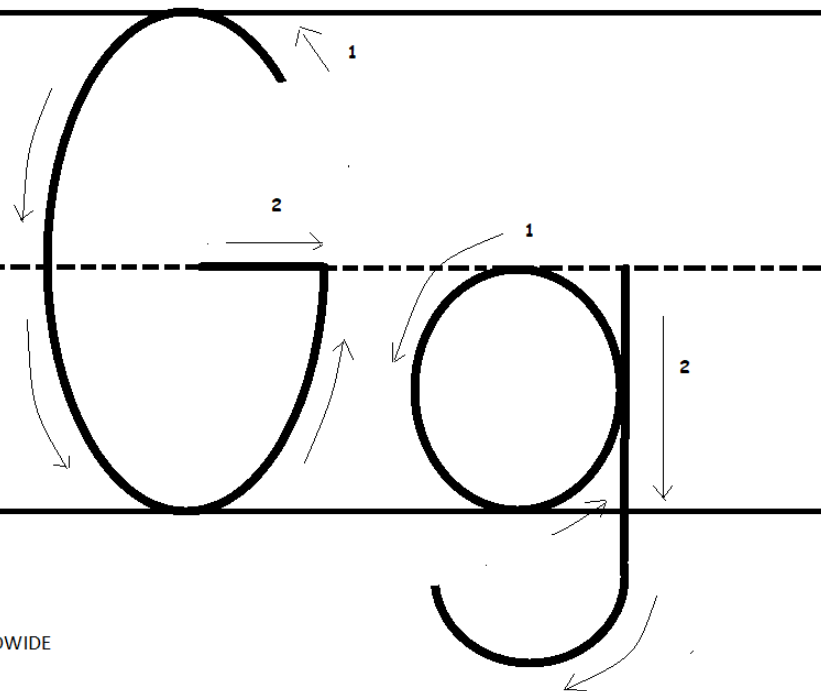

Handwriting With Handwriting Hank! THE WORK BOOK Prophet-Pastor Anita Hiltz ©2022 ALL RIGHTS RESERVED WORLDWIDE

Handwriting practice lines consisting of multiple sets of three horizontal lines: a solid top line, a dashed middle line, and a solid bottom line.

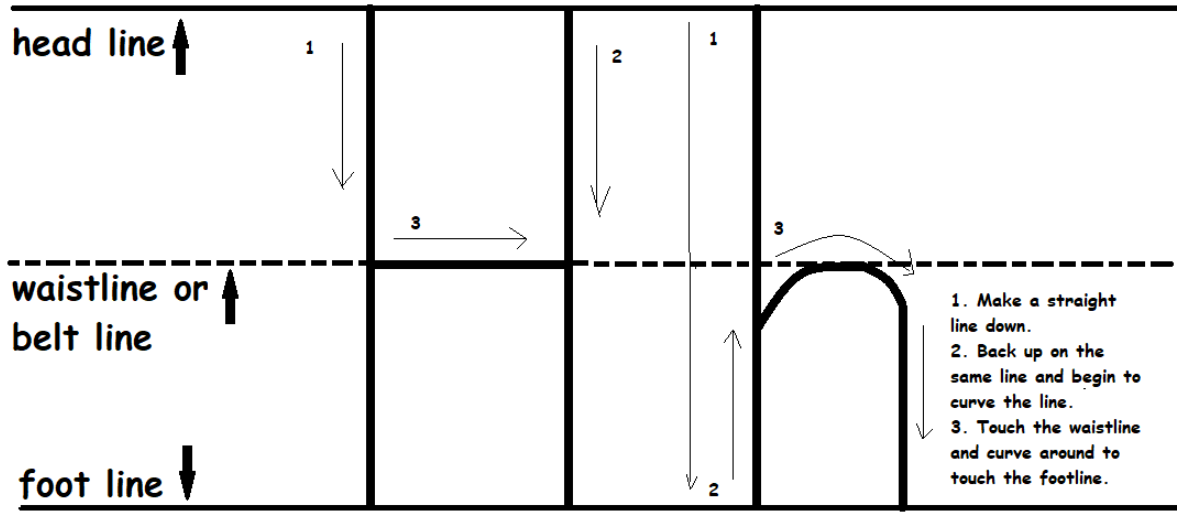
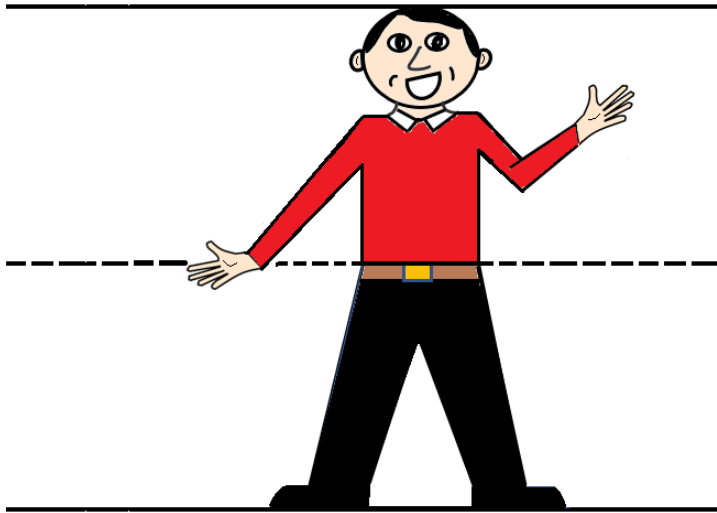

Handwriting practice lines consisting of multiple sets of three horizontal lines: a solid top line, a dashed middle line, and a solid bottom line.

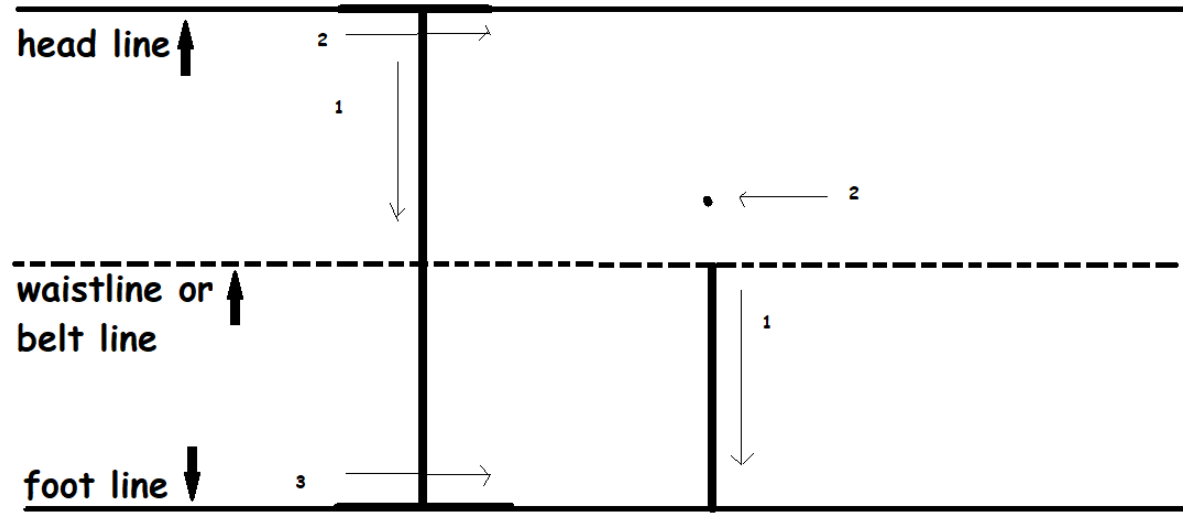
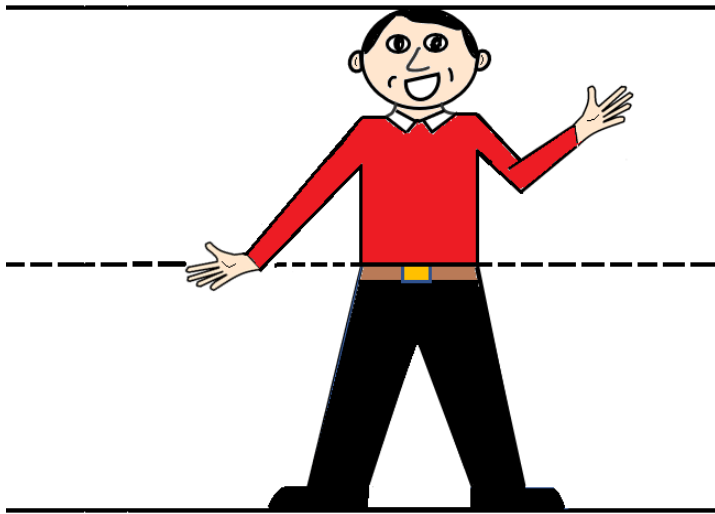

Handwriting practice lines consisting of multiple sets of three horizontal lines: a solid top line, a dashed middle line, and a solid bottom line.

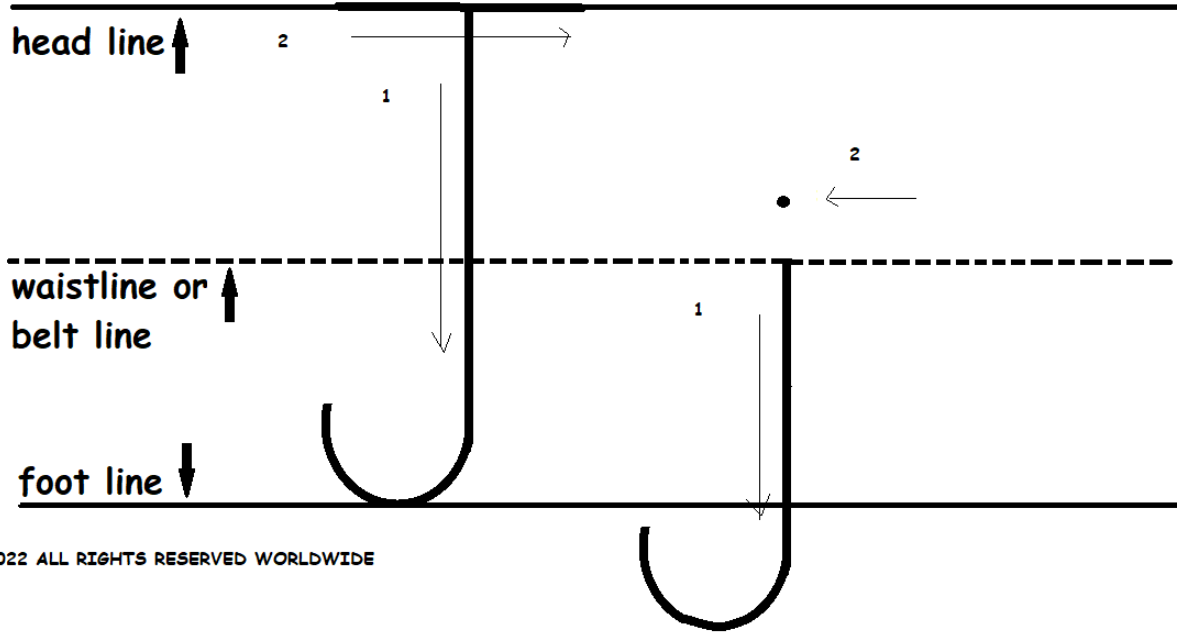
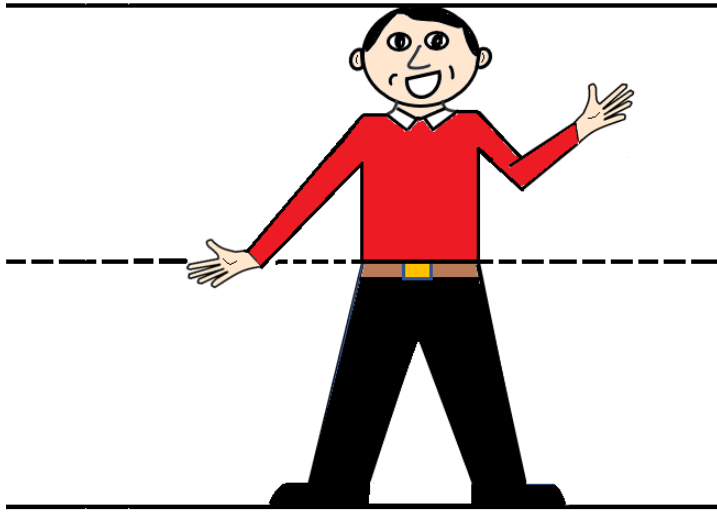

Handwriting with Handwriting Hank! The WORKBOOK Prophet-Pastor Anita Hiltz©2022 ALL RIGHTS RESERVED WORLDWIDE

Handwriting practice lines consisting of multiple sets of three horizontal lines: a solid top line, a dashed middle line, and a solid bottom line.

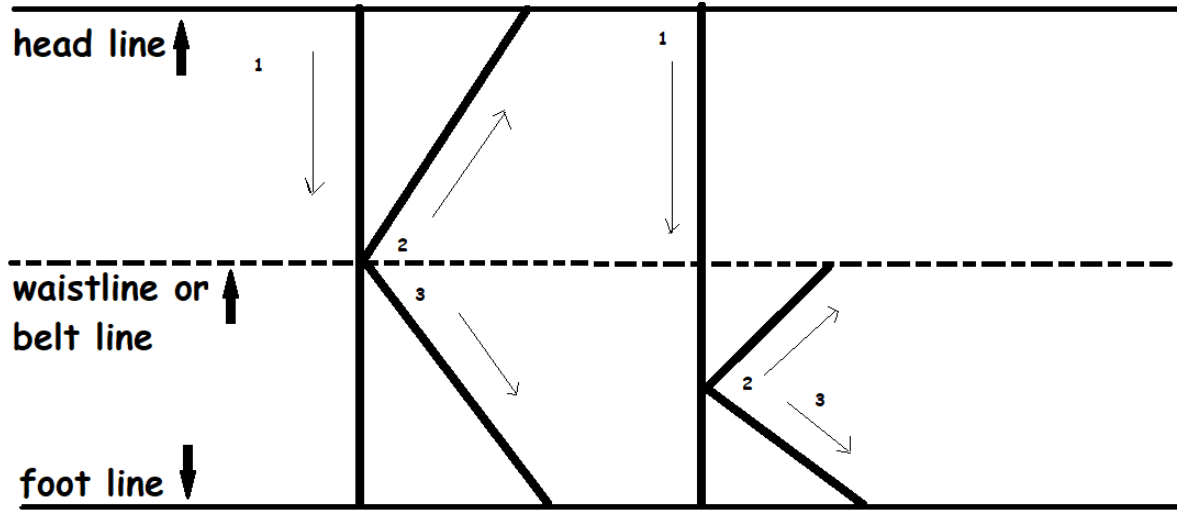
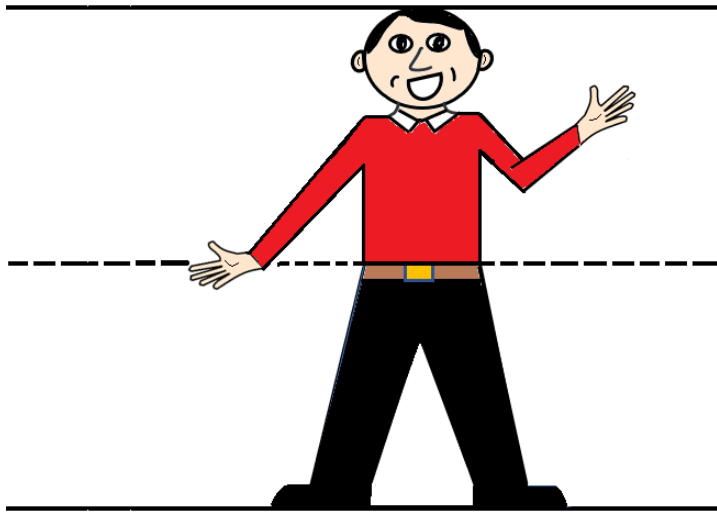

Handwriting practice lines consisting of multiple sets of three horizontal lines: a solid top line, a dashed middle line, and a solid bottom line.

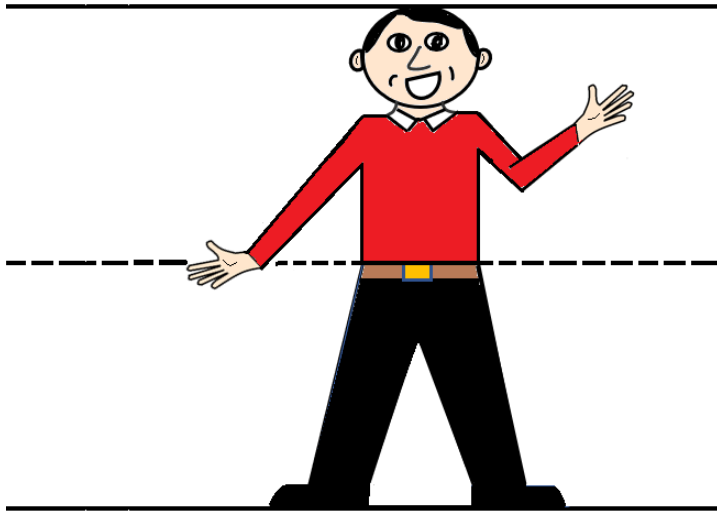

head line ↑

1

waistline or  
belt line ↑

foot line ↓

2

1

Handwriting practice lines consisting of 10 sets of three horizontal lines: a solid top line, a dashed middle line, and a solid bottom line.

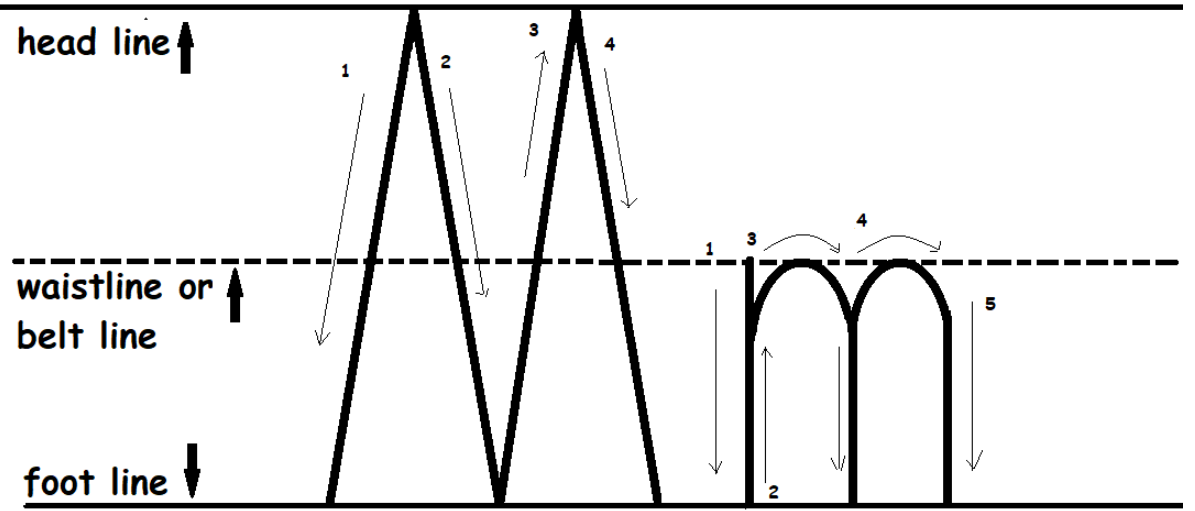
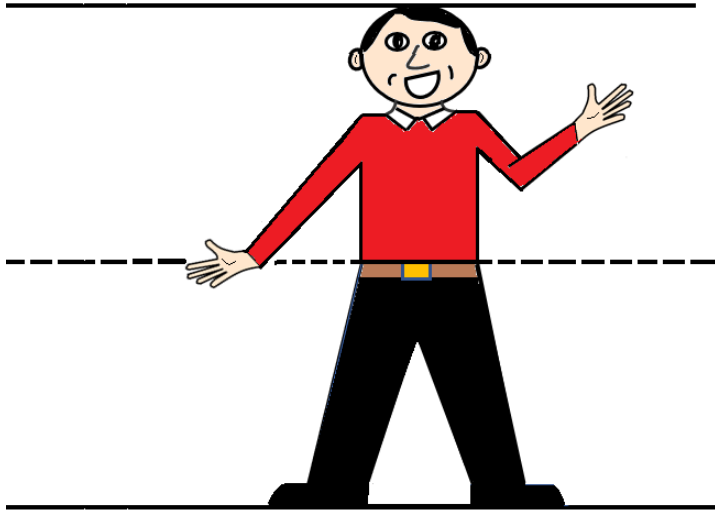

Handwriting practice lines consisting of multiple sets of three horizontal lines (solid top, dashed middle, solid bottom) for practicing the letter 'N'.



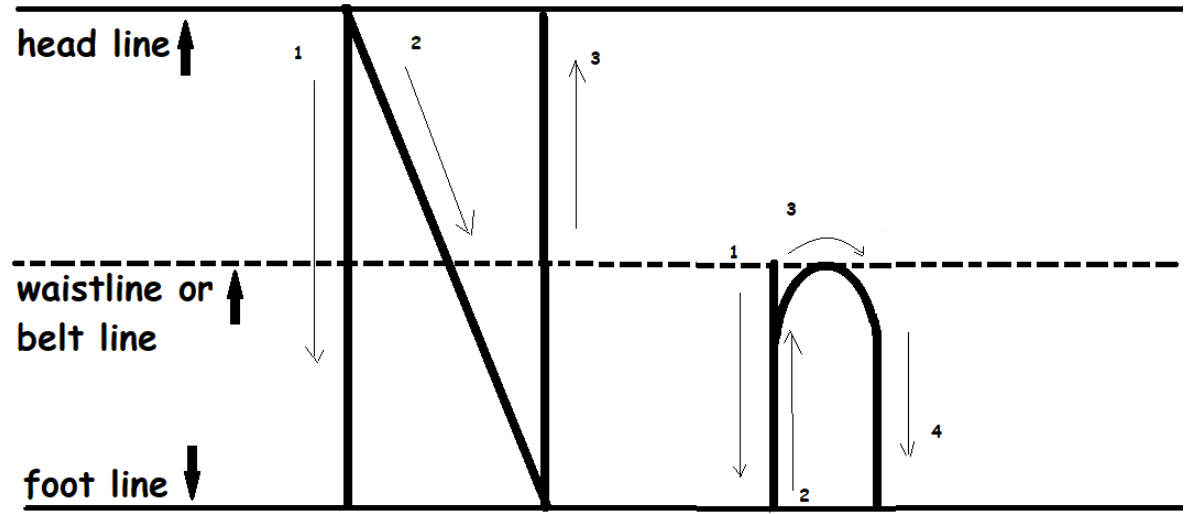
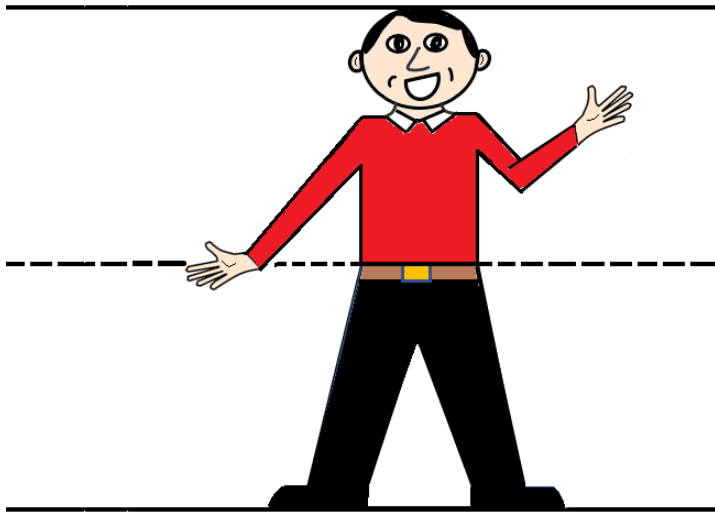

Handwriting practice lines consisting of multiple sets of three horizontal lines: a solid top line, a dashed middle line, and a solid bottom line.

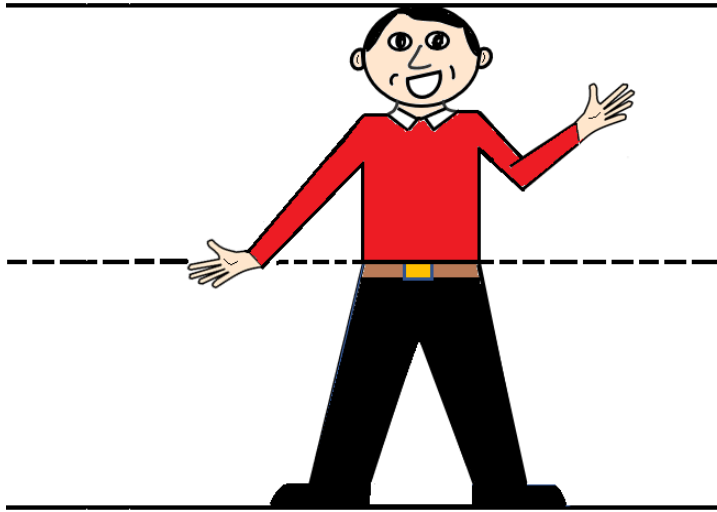

head line ↑

waistline or  
belt line ↑

foot line ↓

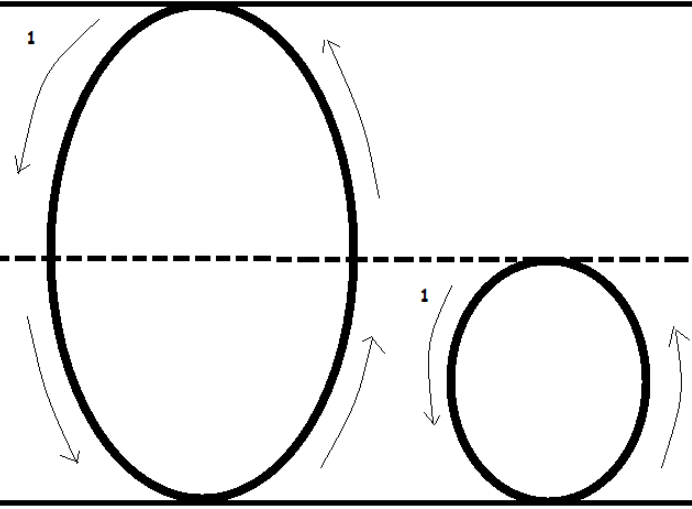

Handwriting practice lines consisting of five sets of three horizontal lines: a solid top line, a dashed middle line, and a solid bottom line.

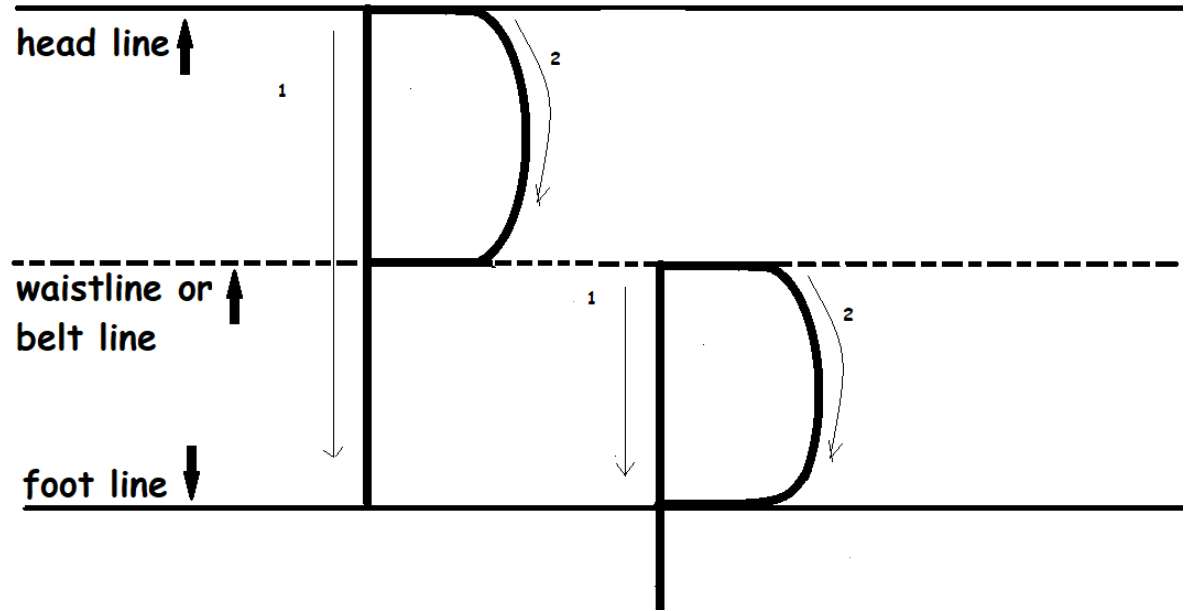
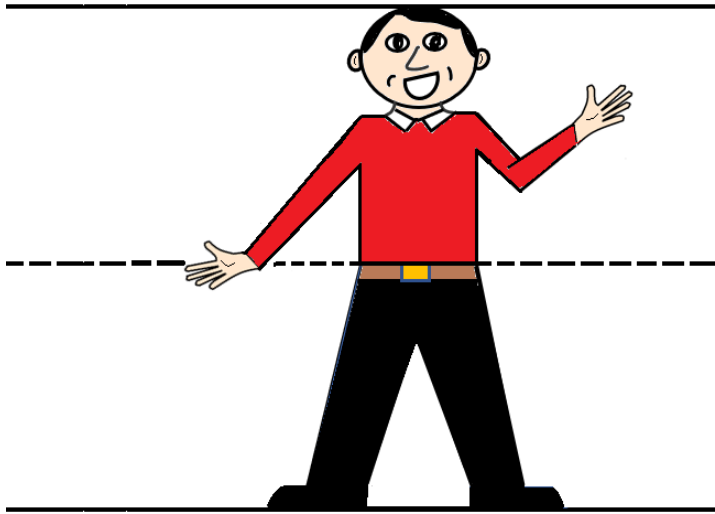

Handwriting practice lines consisting of three sets of horizontal lines: a solid top line, a dashed middle line, and a solid bottom line.

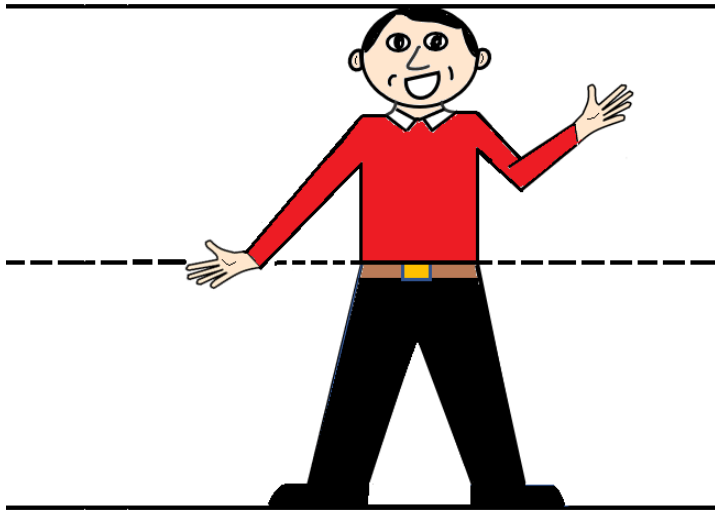

head line ↑

waistline or  
belt line ↑

foot line ↓

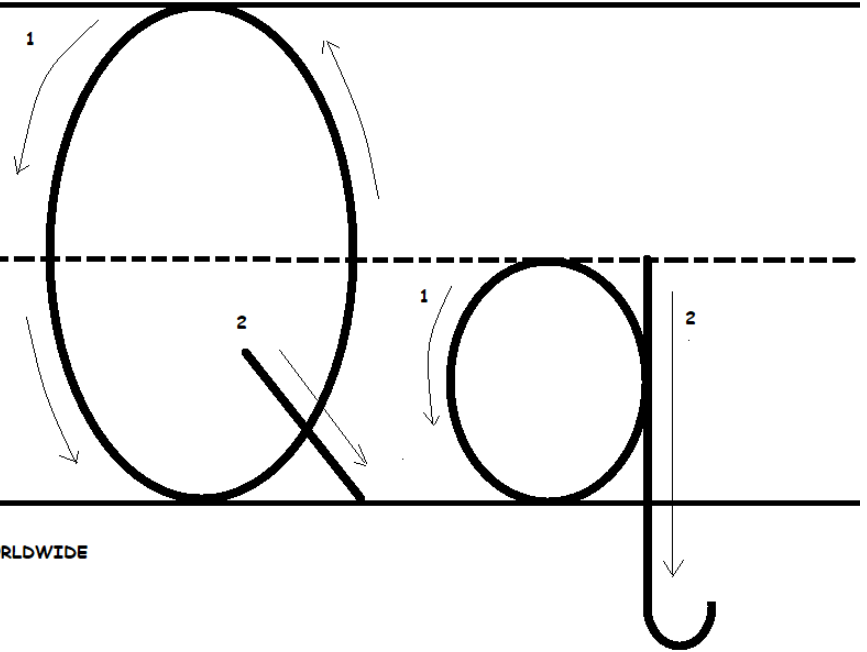

Handwriting with Handwriting Hank! THE WORK BOOK Prophet-Pastor Anita Hiltz© ALL RIGHTS RESERVED WORLDWIDE

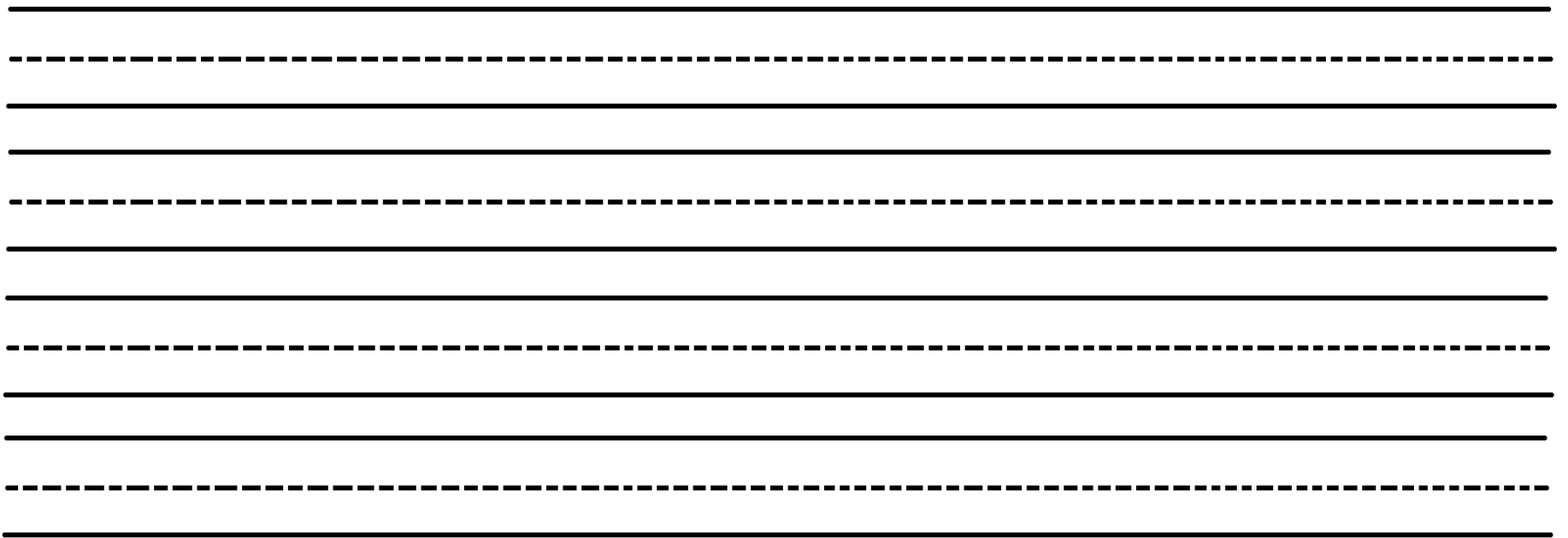

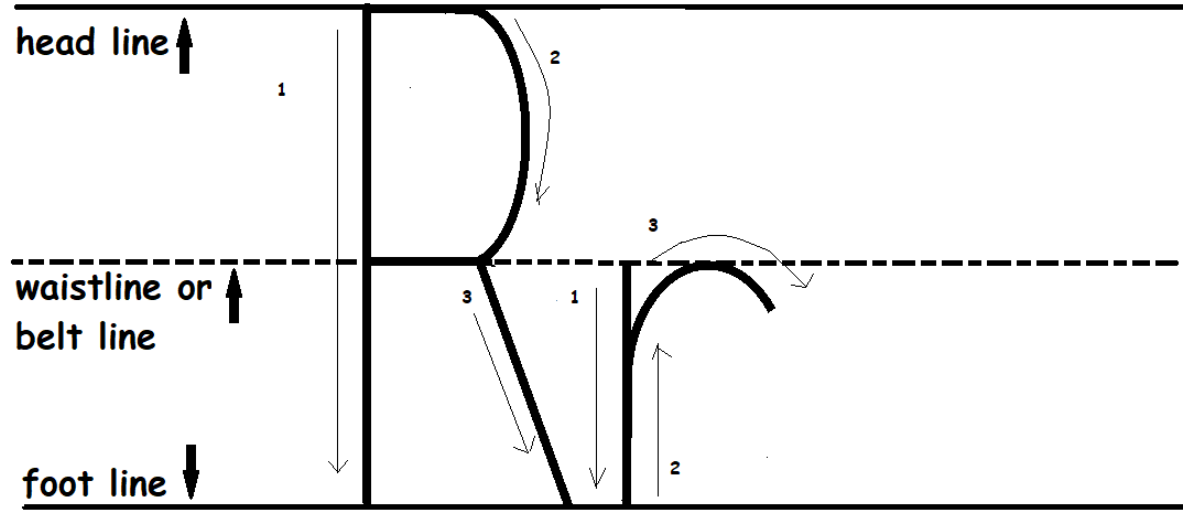
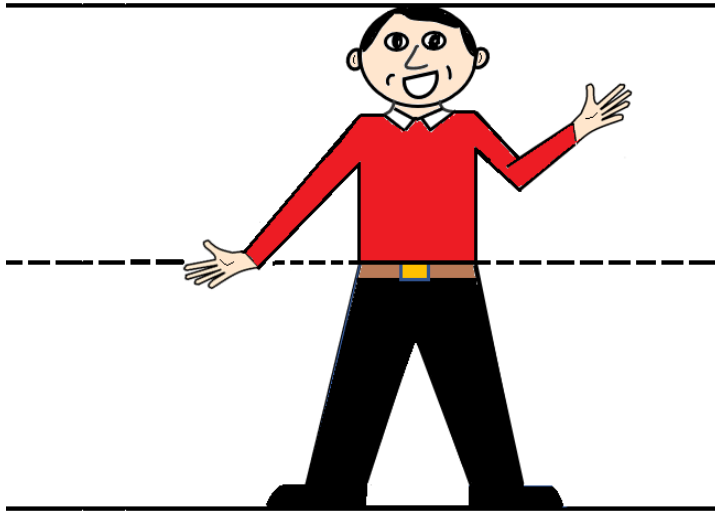

Handwriting practice lines consisting of multiple sets of three horizontal lines: a solid top line, a dashed middle line, and a solid bottom line.

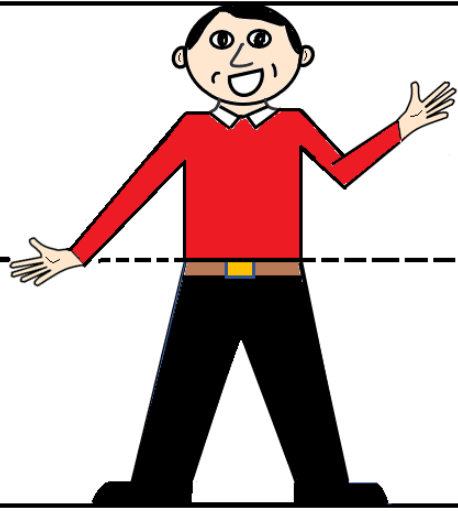

head line ↑

waistline or  
belt line ↑

foot line ↓

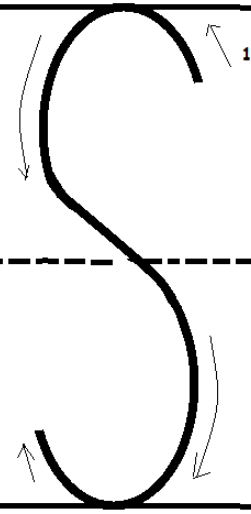

Handwriting practice lines consisting of multiple sets of three horizontal lines: a solid top line, a dashed middle line, and a solid bottom line.

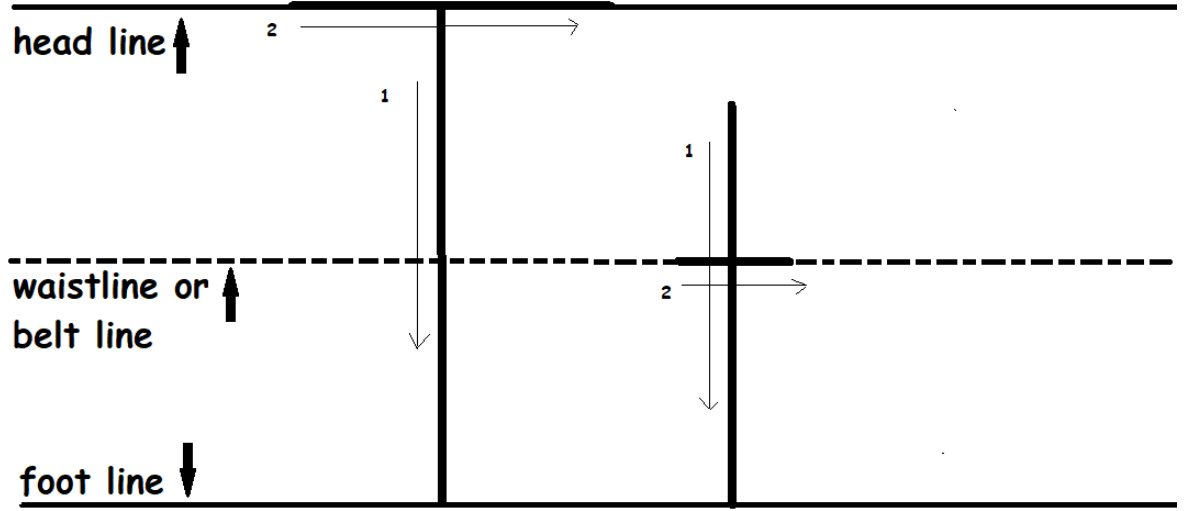
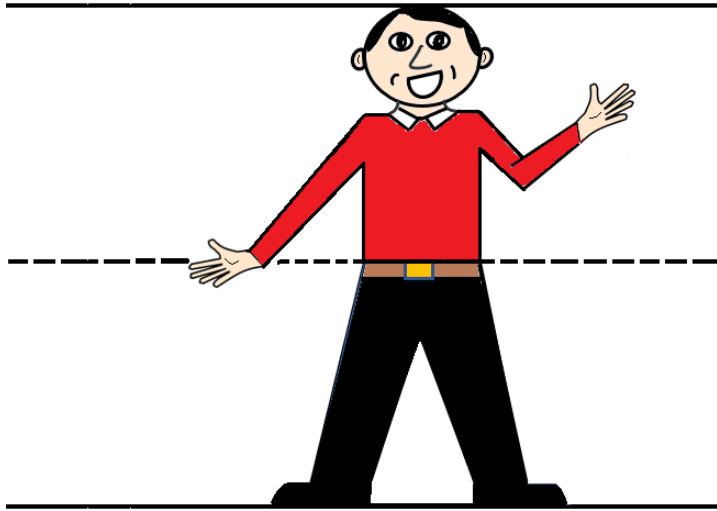

Handwriting practice lines consisting of multiple sets of three horizontal lines (solid top, dashed middle, solid bottom) for writing practice.

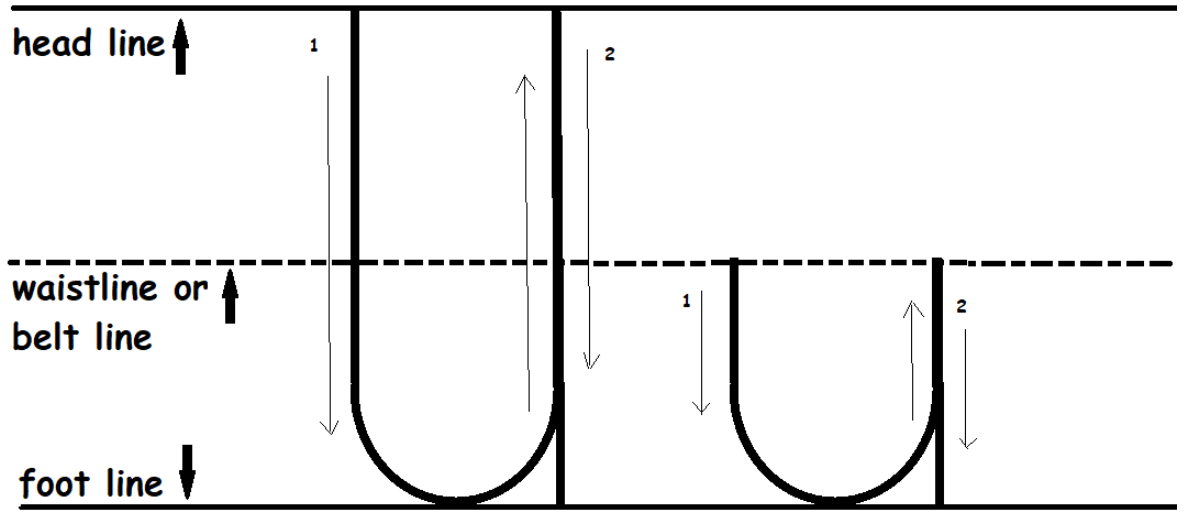
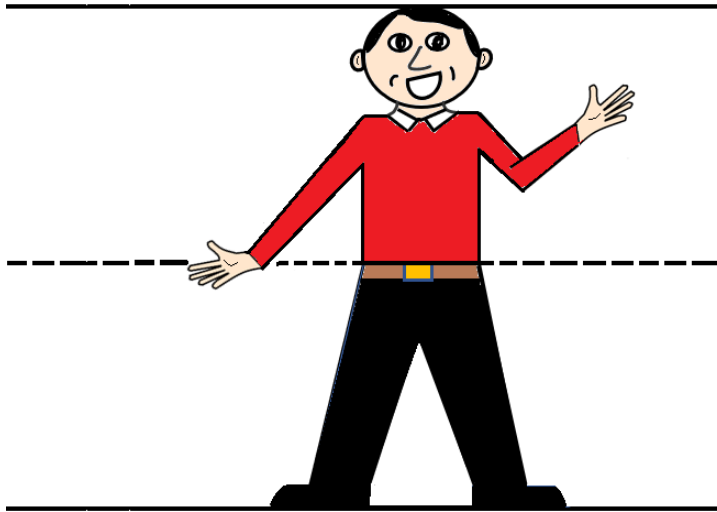

Handwriting practice lines consisting of multiple sets of three horizontal lines: a solid top line, a dashed middle line, and a solid bottom line.



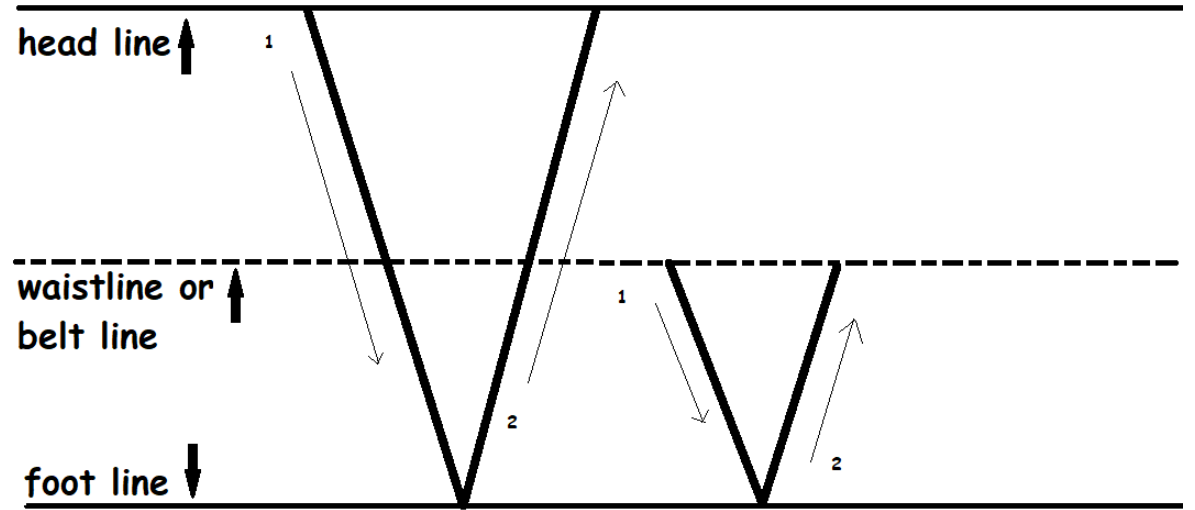
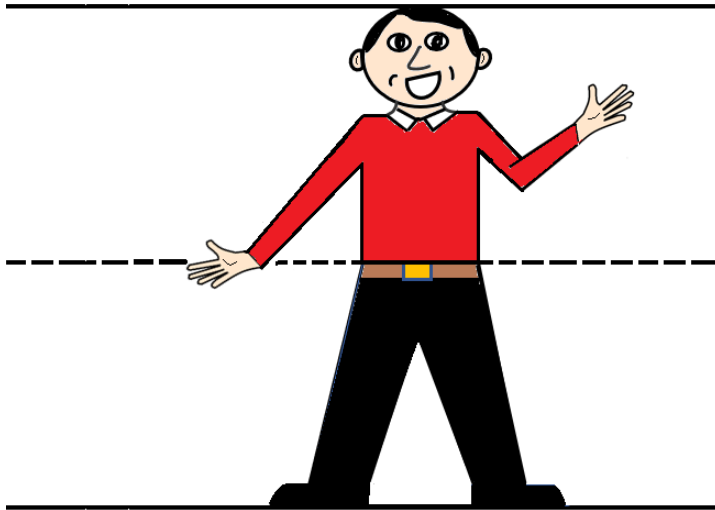

Handwriting practice lines consisting of multiple sets of three horizontal lines: a solid top line, a dashed middle line, and a solid bottom line.

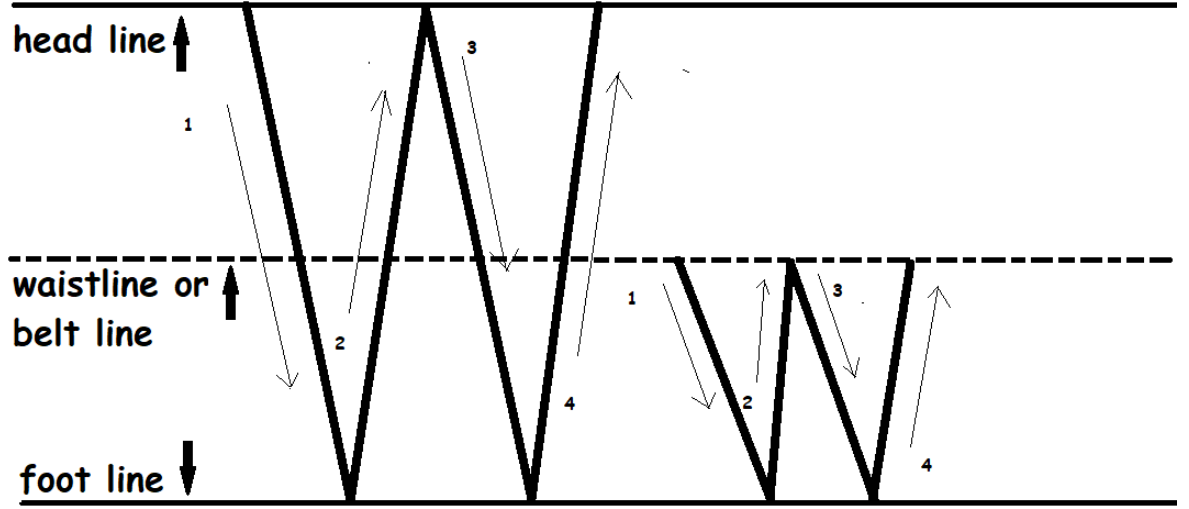
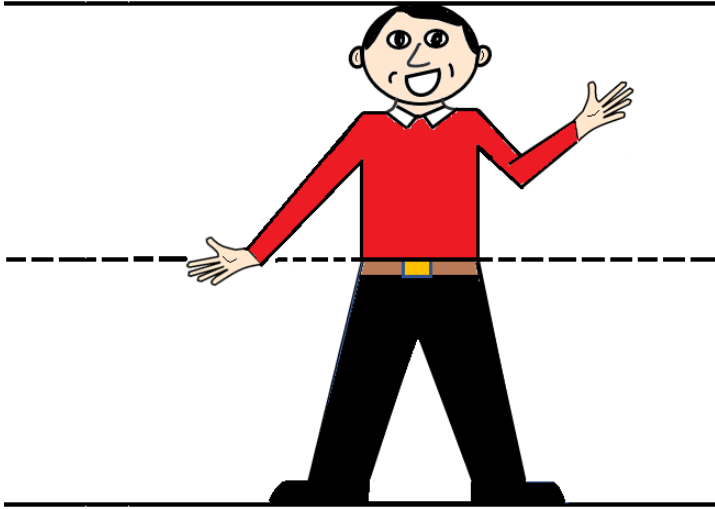

Handwriting practice lines consisting of multiple sets of three horizontal lines: a solid top line, a dashed middle line, and a solid bottom line.

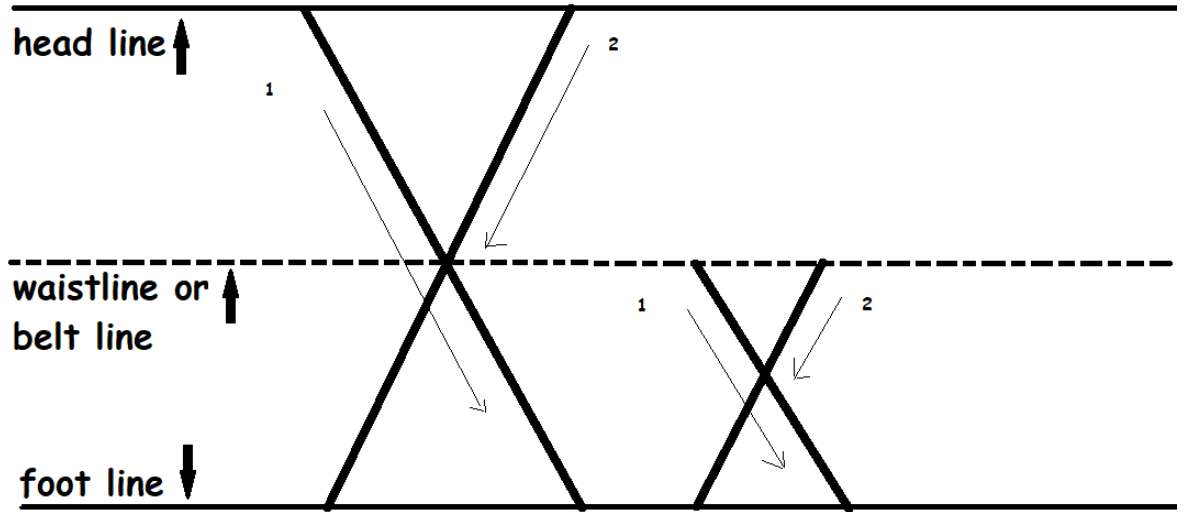
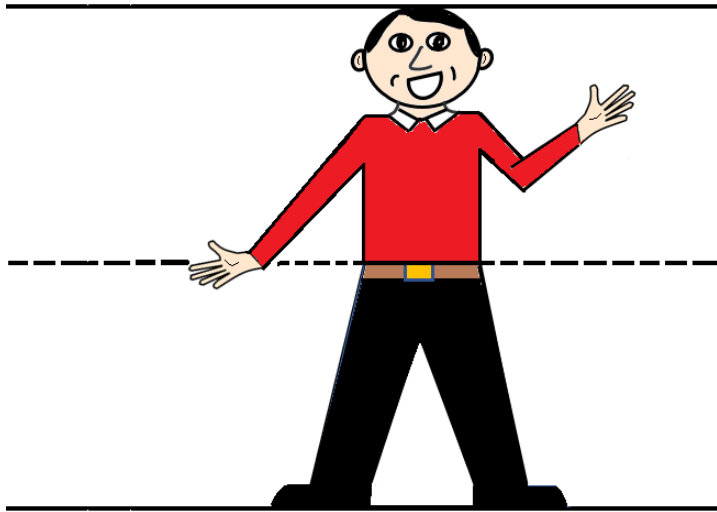

Handwriting practice lines consisting of multiple sets of three horizontal lines: a solid top line, a dashed middle line, and a solid bottom line.

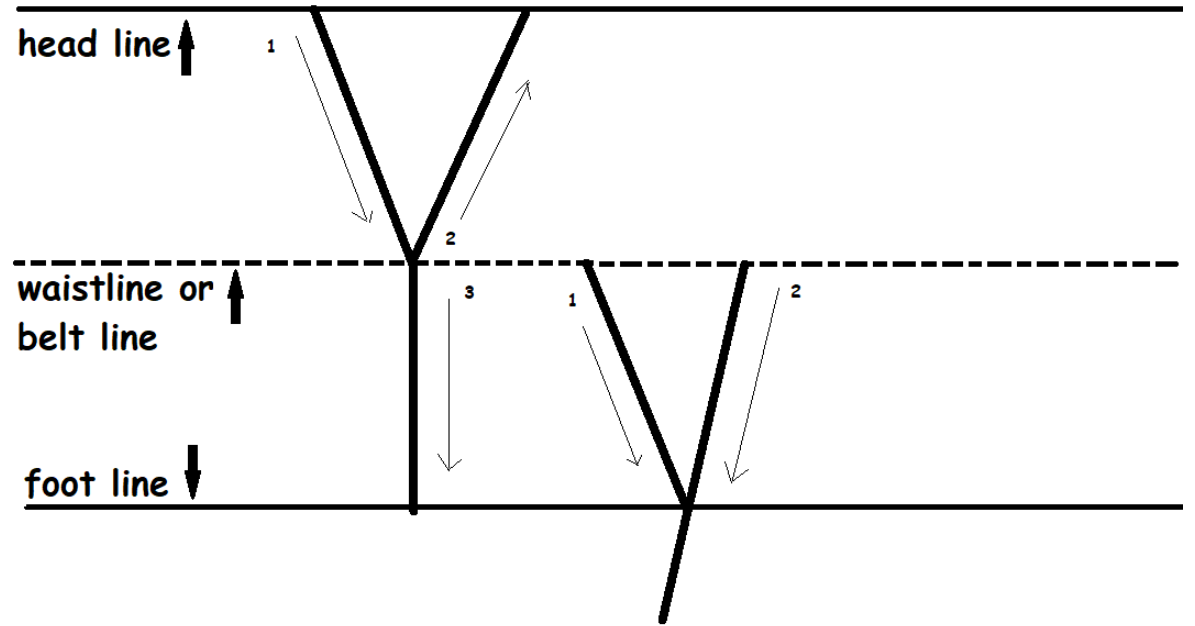
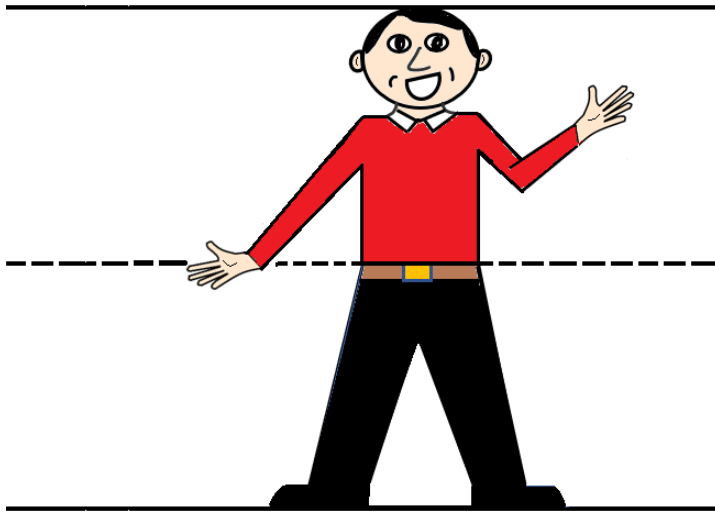

Handwriting practice lines consisting of four sets of three horizontal lines: a solid top line, a dashed middle line, and a solid bottom line.

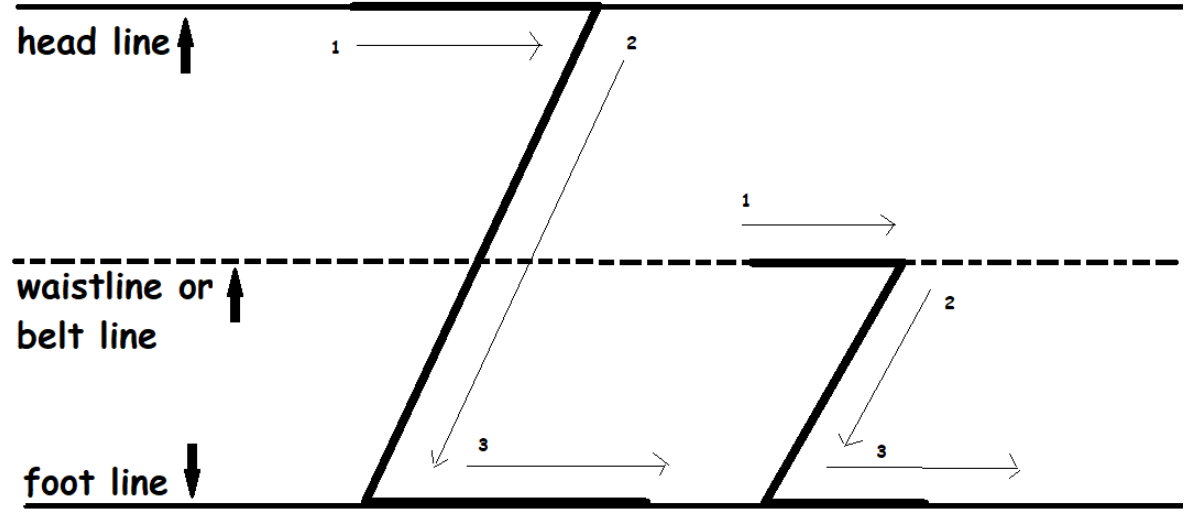
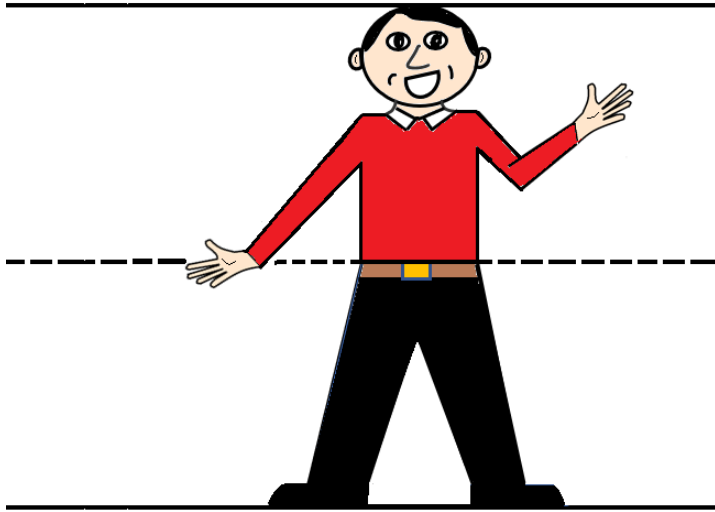

Handwriting practice lines consisting of multiple sets of three horizontal lines: a solid top line, a dashed middle line, and a solid bottom line.

Lord Jesus the Christ,  
I've made so many mistakes I must confess.  
I repent of them now and turn from them.  
I no longer want that mess.  
Lord Jesus, I believe you are the Son of God  
and believe in your resurrection.  
I want to be a child of God  
and receive your love and affection.  
Lord Jesus the Christ, be my Savior.  
Come into my heart.  
Cleanse me now of all unrighteousness  
and give me a brand-new start.  
I ask for the baptism of the Holy Spirit  
and the baptism by Holy fire too.  
I WANT to be changed and to do the RIGHT things  
I need help from you.

Please help me to read, write, and do my math.

I want to start learning today.

I want my life to take a turn  
and start in a whole new way.

Thank you, Lord Jesus, for helping me to learn.

I KNOW you can help make my ability,

greater than anyone ever imagined

and bring back my self-respect and dignity.

I ask this in the name of the Lord Jesus the  
Christ.

I say "Amen" and make it sure.

Now I'll start learning the RIGHT way.

I KNOW Lord Jesus, YOU are the door.

AMEN!

What should you do now as a new Christian?

Ask the Lord where you should be going to church. What is the church that He would like you to go to?

You should also be baptized by immersion, meaning that you're dunked totally under the water, in the name of Father God, the Lord Jesus Christ, and the Holy Spirit.

You are dunked and brought right back up, that's the way Christ was baptized and we're supposed to follow HIS example of what to do.



Brought to you by:

God's Loving World Ministries™

"Planting Seeds To Teach A Man To READ,

So He Can Learn For A Lifetime!"™



[www.capitalg-ingodslovingworldmin.org](http://www.capitalg-ingodslovingworldmin.org)